

Leica 3D Disto

Recreating the real world



 **SWISS** Technology
by Leica Geosystems

- when it has to be **right**

Leica
Geosystems

Beautifully productive

Your new partner for
efficient room measurement

MEASURES

... in 3-dimensions with high precision.

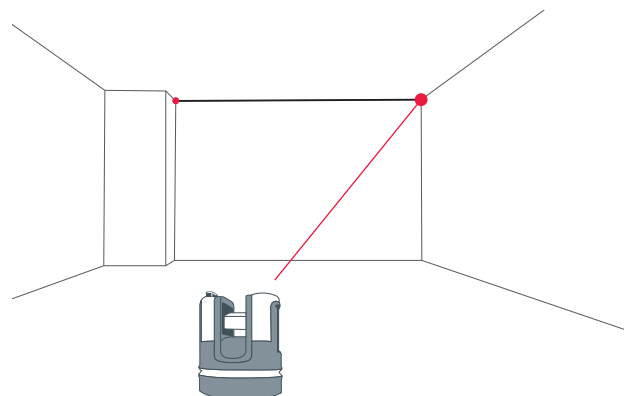

PROJECTS

... point for point.

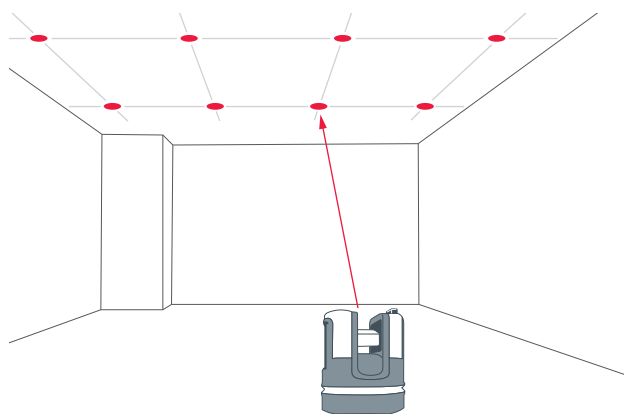

RECORDS

... in various formats.

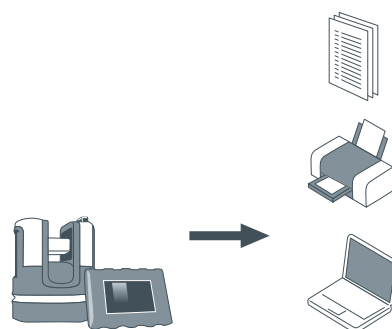

Uniquely versatile

A master of measurement

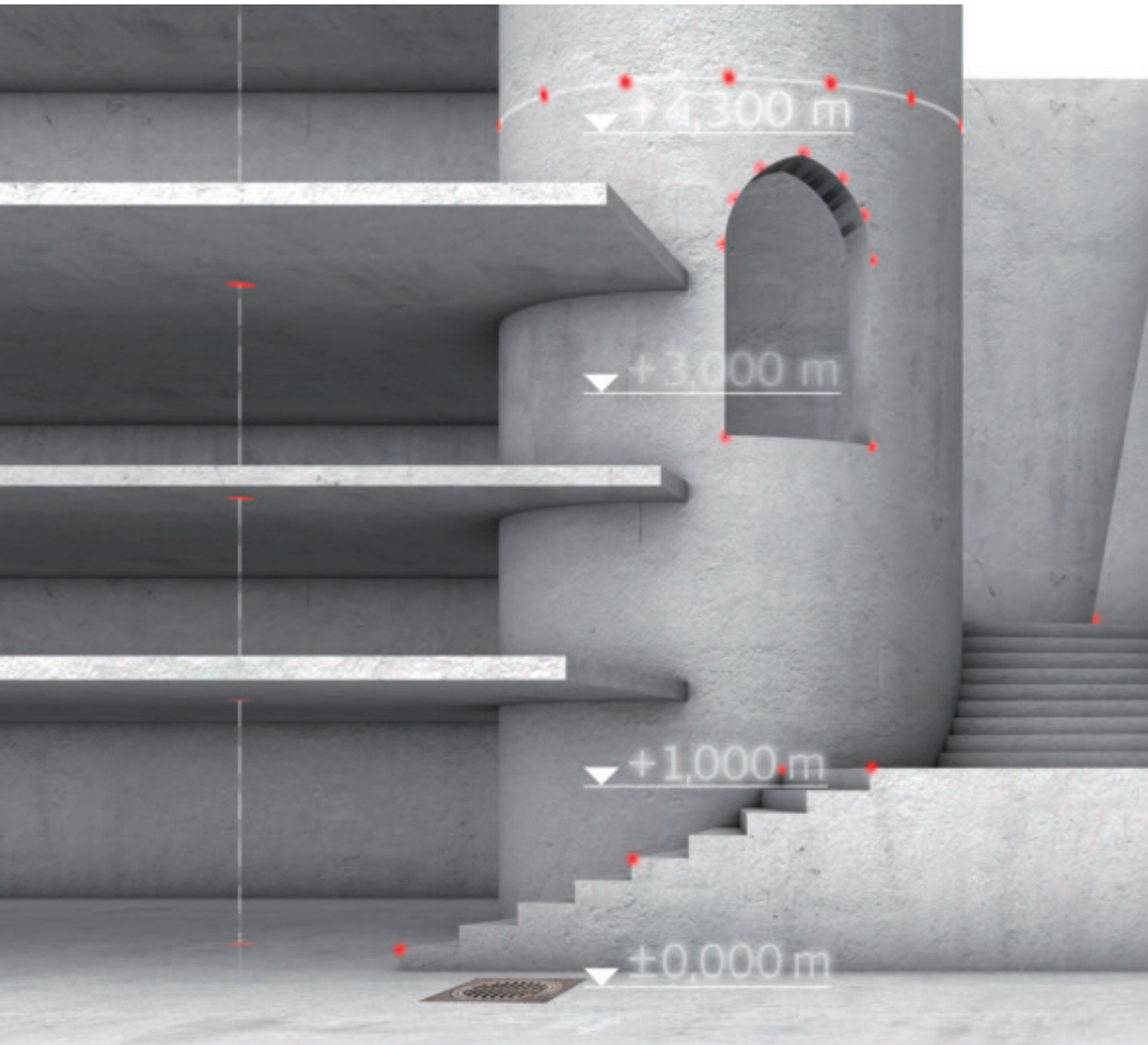

Leica 3D Disto

Stay in control – in whatever shape of room. Capture and record distances, areas, inclinations, and angles effortlessly, even for inaccessible points. Forgotten measurements and handwriting errors are things of the past.



Room scan

Whether in fully automatic or manual mode: you can measure complete rooms, walls, windows, structural connections or stairs – from only one station point.

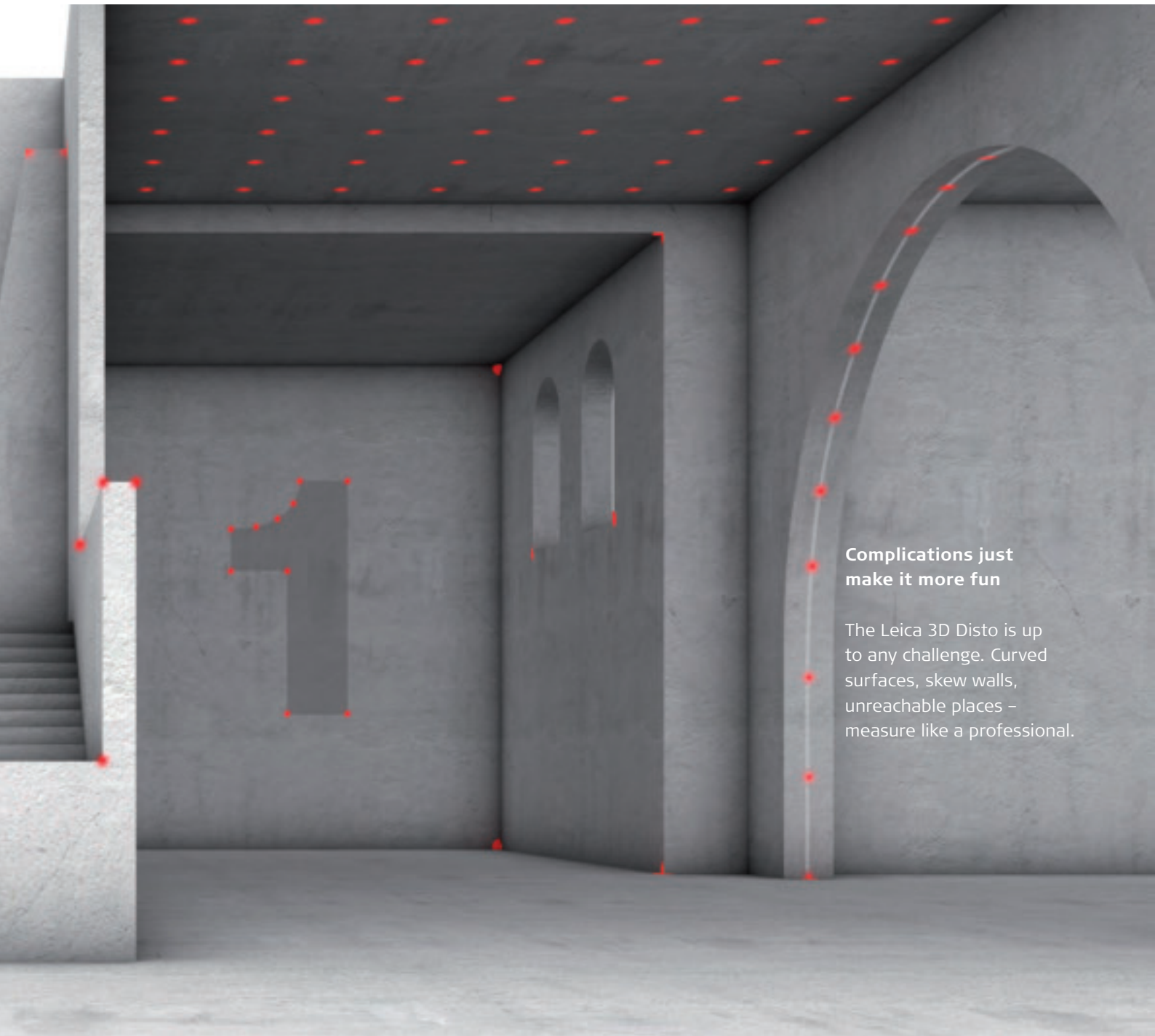

**Complications just
make it more fun**

The Leica 3D Disto is up to any challenge. Curved surfaces, skew walls, unreachable places – measure like a professional.



Projector

Right to the point. Whether ceiling grid or project layout for floors or walls – the Leica 3D Disto projects your design onto any surface – point for point.



Tools

Quick tools inspire the user: establish plumb, create level reference points, or precisely transfer offsets or locations.



Leaves no room for error

Praise from the professionals

Whether it is measuring, setting out or projecting, creating or amending drawings ... the Leica 3D Disto will be up to all your challenges.



Plumber

In earlier days it took two of us to measure a room or transfer the plan from floor to ceiling. Today I work alone with the Leica 3D Disto. By simply projecting or setting out points, parallel lines, level references and grids – it could not be quicker or more reliable.



Kitchen installer

An incorrect measurement here, a forgotten distance there. As a small business, this sort of error can cost me a lot of money. But now I have a Leica 3D Disto, everything is under control! I can measure rooms automatically and export all the drawings and measurements into my CAD software. 100% error-free!



Roofer

A real challenge for me and my colleagues: To measure a roof from the ground accurately and quickly. But now we have the Leica 3D Disto! I can finish a quotation in record time.

Building manager

I must have everything up-to-date! For servicing and maintenance I need absolutely current drawings and 3D data. Earlier I would have to take each measurement, make sketches and then enter it all into the computer. The 3D Disto gives me the complete room data; that accelerates the process.





The latest product from the laser measuring pioneer

Three dimensions – one solution

The Leica 3D Disto is a robust, precisely manufactured measuring instrument. A highly accurate combination of distance and angle measurements determine the precise position of each point targeted with the integral camera and captured with the laser beam. In short: the Leica 3D Disto detects the location and the height of the target point.



It can do everything

- Measure plan position, height and distance, in all three spatial axes
- Intuitive user guidance from Assistants
- Measure from one station – every visible point can be measured by targeting with the visible laser dot – without the need to walk to the target
- Measure to difficult-to-reach points, such as roof edges
- As-built records of ceiling, floor and roof surfaces, volumes, inclination, falls, height differences, angles
- Plumbing of points, parallel offsetting of axis, levelling, transferring levels from wall to wall. Forget spirit level and measuring tapes!
- Realtime display of measurements as drawings on the screen
- Positionally accurate representation of the measured points in the camera display
- Pocket calculator
- Recording information in the form of standard tables, photos, DXF files, text files at the press of a button
- Remote control measurements
- Data import and export on PC and USB stick

Control is by a practical hand-held unit – or wirelessly by WLAN. The measurements can be triggered on the clear, high-resolution screen and displayed as a drawing. For tasks that require you to keep your hands free, there is the simple remote control handset – it has never been more convenient.

And has all this

- Precision:
Accurate to 1 mm at 10m
- Hand-held unit with a modern touch screen, high-resolution color display
- Wireless connection between sensor and hand-held unit eliminates the hassle and limitation of cables. Walk to your target and see where you are measuring
- Digital pointfinder with 8x zoom for precise pointing over longer distances
- Integrated camera
- Sensor can be placed on any stable surface or mounted on a tripod using the 5/8" thread

3D Disto



Hand-held unit



Remote control





Measuring a room

It is this simple to create a room

Details are everything when measuring up a room. The application program "Room scan" provides additional functions for measuring wall surfaces and automatically measures areas predefined by you. You can also reference your measurements to your site's level datum.

The big plus with the Leica 3D Disto

- Suitable for all the measurements in the room
- Measurement of separate points referenced to level datum
- Automatically measure all walls surfaces, horizontal or vertical: Simply define the area to be measured, the spacing between measurements and start. No detail is forgotten, angles and out-of-plane features are captured
- Fold-out mode: change from plan to elevation – for measuring the details on walls, for viewing visualizations or for checking previously measured values/points
- Useful tools for measuring windows and pipe connections reduce the amount of work involved
- Automatic creation of drawings with borders, folding marks and data export: Data can be printed without the need for further processing

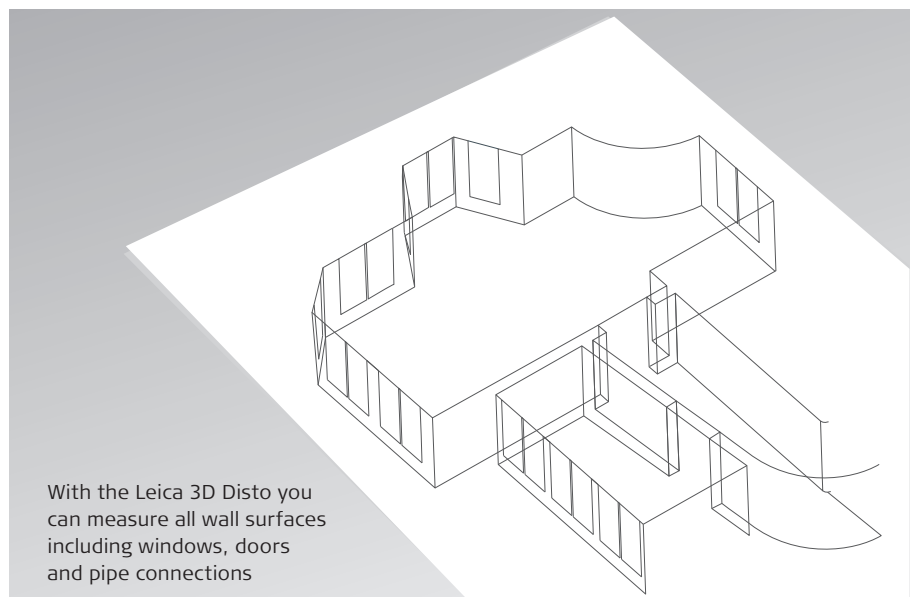

Measure from room to room

With the option "New station point" measuring from one room to the other is child's play.

You can save, change and check your station point

- Continue with the measurements after you have changed the station point of the Leica 3D Disto
- Further measurements can be added to previously stored data at any time

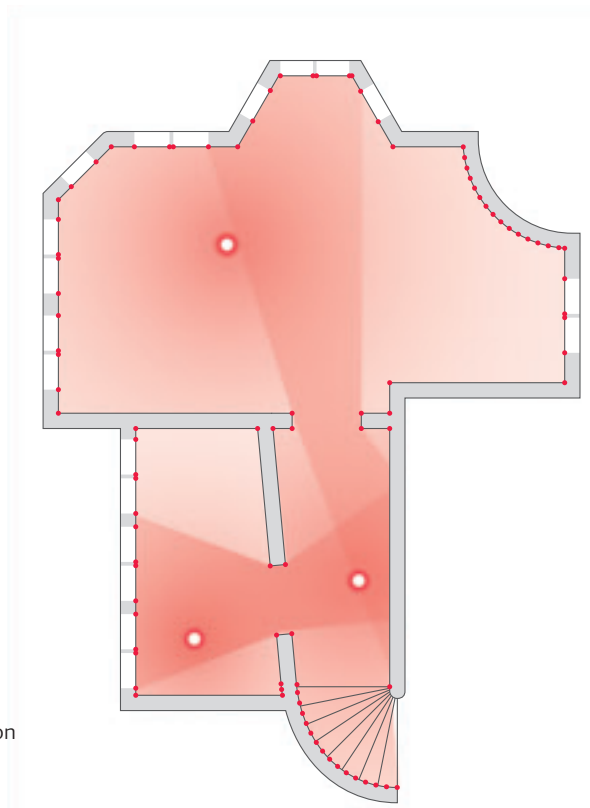

It is all done from the station point: You simply measure from one room to the next.



Projector

Your plans are there to be seen

With the software application "Projector" you can create patterns and grids of existing layouts on the floor, ceiling or wall surfaces. Point for point. One press on the remote control and the next point is displayed. Perfect when you are standing on a ladder or a scaffold and have your hands full.



Point for point precision:

- Determine your grid manually or import it from a preprepared DXF file
- Practical tools to help you adjust your methods to suit the surface
- Simply select and measure the first point in plan – and the laser automatically shows the position. It's done!
- And all you need is the remote control, which you use to conveniently control the stakeout from your station point





Tools

Simple, practical, quick

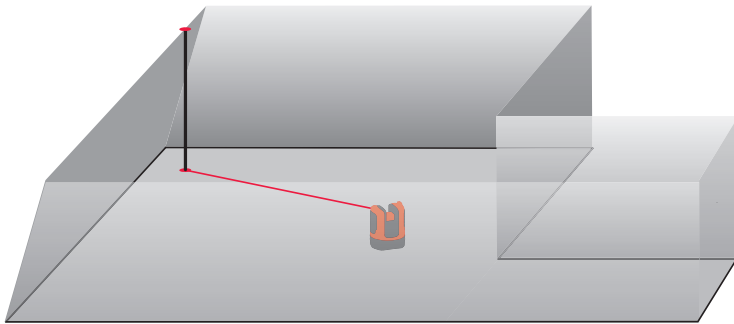

Quick plumbing

Perfect for plumbing points up or down – without having to stand over the plumbing point: you measure to the point to be plumbed. The laser dot shows you the precise position of the plumbed point.

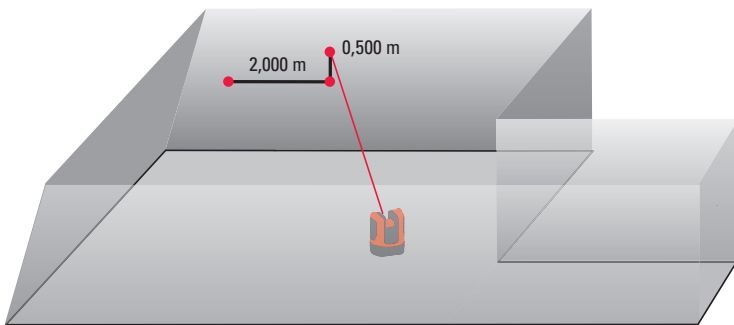

Quick staking out

Mark a point quickly and easily on a wall: Simply point, define the horizontal or vertical distance. The desired point is displayed at the press of a button.

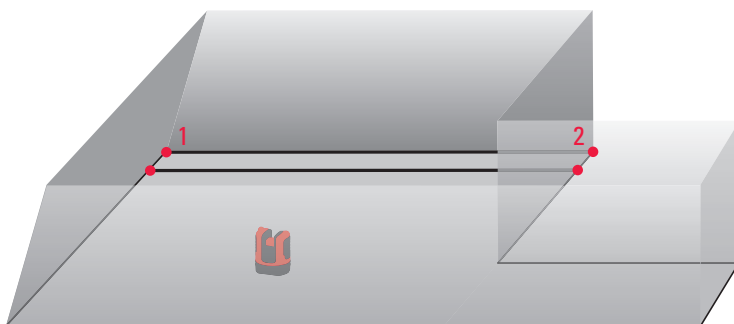

Parallel lines

Measure two points on a straight line and enter a parallel distance. Wherever you now point, the laser dot moves precisely on the parallel line.



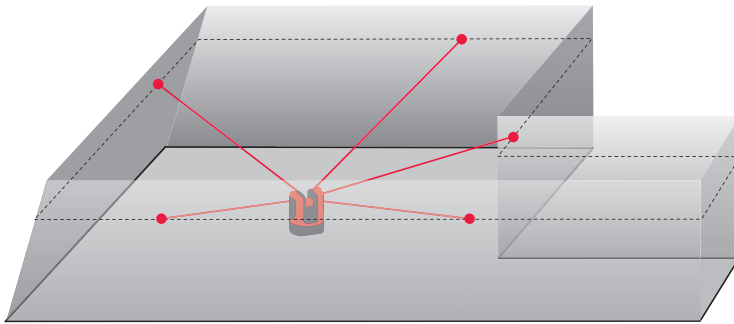

Level

Mark and measure the reference points at the same height on the walls and sloping surfaces. Installing e.g. ceiling tracks: Simply measure the reference point and point at the stakeout position.

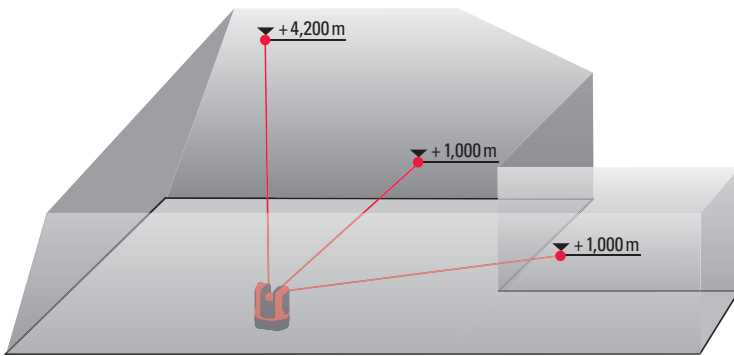

Level reference plates

Attach the level markings and measure the height differences to a reference point. Ideal e.g. for attaching and transferring level reference plates.

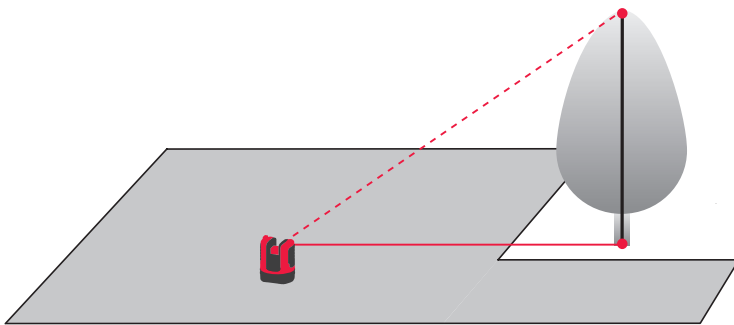

Height control

Some heights are difficult to determine because you cannot measure a direct distance, e.g. with trees or overhead power lines in the way. Just measure one point on the floor and turn the instrument towards the target point. The height is calculated.

Room for perfection
Feel at ease





Large room? No right angles? Skewed walls? Many details? Difficult to reach? No cause to worry: The Leica 3D Disto measures everything you need. Ladder? Mobile access platform? You can leave them back at base.

No tripod on hand? Makes no difference – simply place the 3D Disto on a table or the floor. Levelling up? Not necessary. Photographs for the records? No problem, the in-built camera provides the pictures.

Move about the room with the hand-held unit – wireless.

Measure by remote control. Only five keys – far fewer than a TV handset.

You have mastered the room – with effortless ease. A good feeling, to have everything under control.

All stored

Nothing gets lost

Say goodbye to illegible hand sketches! The Leica 3D Disto records every measurement. The file management system comprehensively documents all your projects, measured data and photos, making them available to you for further processing.

Perfect interfacing with your PC

All data is prepared for export to your PC or USB stick at the touch of a button. Standard data formats for lists, tables, photos and drawings mean the results can be readily imported, viewed and further processed.

.dxf

.csv

.txt

.jpg



Technical specifications

At a glance

Features of goniometer (Hz/V)	Range of measurement	Horizontal 360°; vertical 250°		
	Accuracy	5", equates to 1.2 mm @ 50 m		
Features of laser distance meter	Type	Coaxial, visible red laser		
	Range of measurement	0.5–50 m		
	Laser class	2		
	Laser type	650 nm; < 1 mW		
	∅ laser dot (at distance)	10 m:	~7 mm × 7 mm	
	30 m:	~9 mm × 15 mm		
Tie distance accuracy (3D)	Combination of angle and distance	@ 10 m	@ 30 m	@ 50 m
		Approx. 1 mm	2 mm	4 mm
Tilt sensor	Self-levelling range	± 3°		
	Accuracy	10", equates to 2.5 mm @ 50 m		
Digital pointfinder	Zoom (magnification)	1x, 2x, 4x, 8x		
	Field of view (@ 10 m)	1x:	3.40 m × 2.14 m	
		2x:	1.70 m × 1.07 m	
		4x:	0.85 m × 0.54 m	
		8x:	0.42 m × 0.27 m	
Circular level setting accuracy*		1°/mm		
Operation	Screen	High-resolution screen, 800×480 pixels, 4.8" TFT LCD, 16 million colors		
	Keys/user interface	3D Disto: 1 On/Off button Hand-held unit : touch screen, 1 On/Off button		
	Memory	Flash memory 32 GB		
	Interfaces	3D Disto: USB type B, power supply power pack, power supply to hand-held unit Hand-held unit: USB type A, power supply power pack		
Communication	Cable	USB: Micro-B USB and type A, WLAN		
	Wireless	SD card, range: 50 m (depending on environment)		
	Data format	Import DXF; export DXF, TXT, CSV, JPG		
Power supply	Type	3D Disto: Li-Ion battery, voltage: 14.4 V/63 Wh, external power supply: 24VDC/2.5A, charging time 8 h Hand-held unit: Li-Ion battery, 2500 mAh, 3.7V, external power supply: 5VDC/2.0A, charging time 7 h		
	Operating time	3D Disto:	8 h	
		Hand-held unit:	6 h	
Attachment		5/8" thread		
Dimensions (W×H×D)		3D Disto:	∅ 186.6 × 215.5 mm	
		Hand-held unit:	178.5 × 120 × 25.8 mm	
Weight		3D Disto:	2.8 kg	
		Hand-held unit:	0.33 kg	
Environmental conditions	Operating temperature range	3D Disto:	-10 to 50 °C	
		Hand-held unit:	-10 to 50 °C	
	Storage temperature	3D Disto:	-25 to 70 °C	
		Hand-held unit:	-25 to 70 °C	
	Water and dust protection	3D Disto:	IP54 (IEC 60529)	
		Hand-held unit:	IP5x	
	Moisture	Max. 85%, non-condensing		
Remote control (IR)	Range	50 m (depending on environment)		
	Communication	Infrared (IR)		
	Battery	1 AA, 1.5 V		

*Accuracy is specified at 20 °C.



Laser class 2
in accordance with IEC 60825-1

Figure, description and technical data for information only;
subject to change. Printed in Switzerland.
Copyright Leica Geosystems AG, Heerbrugg, Switzerland 2011



myWorld@Leica Geosystems

Keep up with the latest developments

Visit the world of Leica Geosystems at www.leica-geosystems.com and register your Leica 3D Disto at Leica myWorld. You will receive your own individual and secure access to the Internet portal.

Stay up-to-date

In myWorld you can find information on all important aspects of the product: The documentation covers manuals, suggested solutions and is always kept current. The instrument's software can be checked and updated. Nowhere can you find all the tips and information about your Leica 3D Disto presented in such a compact form than at Leica myWorld.

The screenshot displays the Leica myWorld website. At the top, the 'myworld' logo is on the left, and the 'Leica Geosystems' logo is on the right. Below the logos, there is a navigation bar with 'myWorld' and 'News' tabs. A left sidebar contains a menu with 'myProducts', 'myService', 'mySupport', 'myTraining', and 'myDownloads'. The main content area is titled 'myWorld' and features a 'Willkommen!' section with five sub-sections: 'myProducts', 'myService', 'mySupport', 'myTraining', and 'myDownloads'. Each sub-section includes a small image and a brief text description. On the right side, there is a 'Der Kontakt' section with contact information for Leica Geosystems AG, including the address 'Hansstrasse 12, CH-9430 Heerbrugg, Tel. 071 737 31 31'. Below this is a 'Letzte Beiträge' section with three entries, each with a date and a title, such as '14. Oktober 2010: Einführung neuer Produkte' and '8. Oktober 2010: Einrichten & Messen Leica Viva Reflexor'. The footer of the page contains the copyright notice '© Leica Geosystems 2010'.

myProduct

See which software licences you hold. Check on the status of your Leica 3D Disto. Find out whether your software is the current version.

mySupport

Any questions? You can find the right answers here.

myTraining

Use the full potential of your Leica 3D Disto and discover all the possibilities opened up by this fascinating new measuring instrument.

myService

You can't lay your hands on that cable again? Here's where you can find out where to obtain spare parts.



Leica 3D Disto

A good feeling ...

A job well-done, satisfied customer, good feeling, that's how it should be. With the 3D Disto I just know that everything is OK. Even with my very experienced team, I was sometimes uncertain whether all the dimensions agreed; in some circumstances a single mistake could prove very costly. But happily these times are over. With the 3D Disto I am always on the safe side.

www.disto.com

- when it has to be **right**

Leica
Geosystems